



## ***Öhlins Shock Absorber for MC Road & Track***

**Owner's Manual**

# INTRODUCTION



## **Öhlins Racing AB - The Story**

*It was the 1970's, a young man named Kenth Öhlin spent most of his spare time pursuing his favourite sport: motocross.*

*A careful observer, Kenth's attention was continually drawn to one specific detail - motocross bikes had more engine power than their suspension could handle.*

*It was not long before Kenth realised that better performance could be achieved by improved wheel suspension.*

*Öhlins Racing was established in 1976, and just two years later the company won its first World Championship title. Despite being in the business for 30 years, the search for perfection and new functions is still the main focus of the company.*

*Congratulations! You are now the owner of an Öhlins Shock Absorber. More than two hundred World Championships and other major world titles are definitive proof that Öhlins shock absorbers offer outstanding performance and reliability.*

*Every product has gone through rigorous testing and engineers have spent thousands of hours, doing their very best to use every possible experience from our 30 years within the racing sport.*

*The product that you now have in your possession is pure racing breed that is built to withstand.*

*By installing this shock absorber on your bike you have made a clear statement... you are a serious rider with a focus on getting the maximal handling ability and outstanding feedback from your bike. Along comes the fact that your shock absorber will be a long lasting friend, delivering the very best of comfort and performance every time you go for a ride. Go explore!*

# SAFETY PRECAUTIONS

## **Note!**

*The shock absorber is an important part of the vehicle and will affect the stability.*

 *Read and make sure that you understand the information in this manual and the mounting instructions before you use this product. If you have any questions regarding installation or maintenance please contact Öhlins.*

 *Öhlins Racing AB can not be held responsible for any damage to the shock absorber, vehicle, other property or injury to persons, if the instructions for installing and maintenance are not followed exactly.*

## **Warning!**

*This product was developed and designed exclusively for a specific vehicle model and shall only be installed on the intended vehicle model in its original condition as delivered from the vehicle manufacturer.*

 *This product contains pressurized nitrogen gas (N<sub>2</sub>). Do not open, service or modify this product without proper education (authorized Öhlins dealer/distributor) and proper tools.*

 *After installing this product, take a test ride at low speed to make sure that your vehicle has maintained its stability.*

 *If the suspension makes an abnormal noise, or the function is irregular, or if you notice any leakage from the product, please stop the vehicle immediately and return the product to an Öhlins Service Centre.*

 *The product warranty shall only apply if this product has been operated and maintained in accordance with recommendations in this manual. If you have any questions regarding usage, service, inspection and maintenance please contact Öhlins.*

## **Safety Symbols**

In this manual, mounting instructions and other technical documents, important information concerning safety is distinguished by the following symbols:



*The Safety Alert Symbol means: Warning! Your safety is involved.*

### **Warning!**

*The Warning Symbol means: Failure to follow warning instructions can result in severe or fatal injury to anyone working with, inspecting or using the shock absorber, or to bystanders.*

### **Caution!**

*The Caution Symbol means: Special precautions must be taken to avoid damage to the shock absorber.*

### **Note!**

*The Note Symbol indicates information that is important regarding procedures.*

## **Note!**

*When working on this product, always read the Vehicle Service Manual.*

 *This Manual shall be considered a part of the product and shall therefore accompany the product throughout its life cycle.*

© Öhlins Racing AB. All rights reserved. Any reprinting or unauthorized use without the written permission of Öhlins Racing AB is prohibited.  
Printed in Sweden.

# CONTENTS

## In This Manual

	page
<i>Introduction</i>	1
<i>Safety Precautions</i>	2
<i>Contents</i>	3
Design and Functioning	4
Setting Up your Vehicle	6
Adjustments	7
Spring Preload	8
Compression Damping	9
Rebound Damping	10
Adjust Length	11
Adjustment and Set-up	12
Inspection and Maintenance	14



# DESIGN AND FUNCTIONING

Many of Öhlins suspensions are high pressure monotube type shock absorbers. The fluid is put under gas pressure and the gas and the fluid are kept apart by a separating piston. The piston is usually fitted in an external reservoir, connected by a hose (Fig. 4) or fixed directly on top of the shock absorber (Fig 3). In some models everything is fitted inside the main shock absorber (Fig 2).

A few shock absorbers are of emulsion type, oil and gas mixed inside the shock absorber (Fig 1). The fluid is pressurized by nitrogen. The pressurisation prevents cavitation of the fluid and the shock absorbing action is therefore more even. The external reservoir also contributes to better cooling of the fluid, giving longer service life for the fluid as well as the components.

Öhlins shock absorbers with external rebound adjustment have an integrated temperature compensation.

As the temperature increases and the fluid flows more easily the flow is controlled accordingly. The shock absorbing effect is therefore independent of the temperature.

The more advanced models permit individual adjustment of compression and rebound damping.

Öhlins shock absorbers provide the possibility of adjustment, making them adaptable to most vehicles, drivers and ranges of use. All of the shock absorbers with springs have adjustable preload of the spring action.

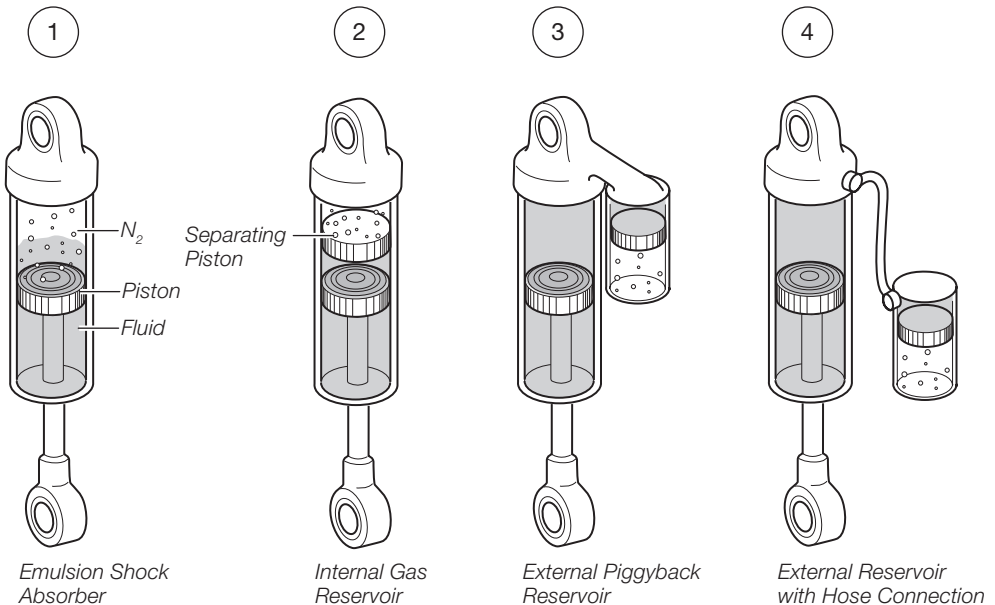

# DESIGN AND FUNCTIONING

Fluid is forced through needle valves at a low rate of flow (Fig 6) and through a number of orifices in the piston (Fig 7) at a high rate of flow. The flow through these orifices is regulated by shims (thin steel washers) that at high pressure are deflected to open for the fluid. On most models the needle valve can be adjusted from the outside.

By altering the size of the shim-stack (Fig 8) (i.e. number, thickness, diameter) the characteristics of the damping action can be changed. *This should only be done by an authorized Öhlins service workshop.*

## Compression damping

When movement of the motorcycle causes compression of the shock absorber, the fluid flows through the needle valve (combined compression and rebound valve) in the piston rod. If the velocity of the compression movement is high, i.e., in the case of rapid compression, this will not be sufficient and consequently the shims underneath the piston will open to allow for a greater rate of flow. The fluid that is displaced by the volume of the piston rod is forced into the external reservoir via a separate compression valve. The separating piston is displaced, thus increasing the gas pressure.

## Rebound damping

When the spring forces the shock absorber to extend again, the fluid flows back through the needle valve. The fluid flowing into the chamber is forced by the pressure of the gas back into the shock absorber via a separate non-return valve. If the piston velocity is high, the shims on top of the piston will also open to allow the fluid to flow through.

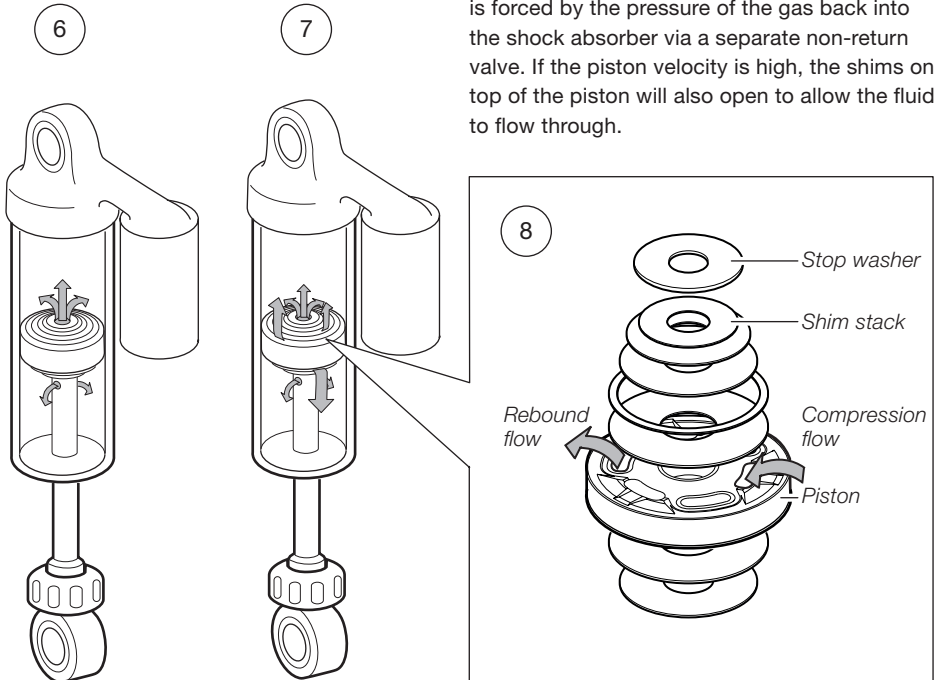

# SETTING UP YOUR VEHICLE

## **⚠ Warning!**

Before riding, always ensure that the basic settings made by Öhlins are intact. Take notes, adjust in small steps and make only one adjustment at a time.

## Step 1

### Spring Preload - Free Sag - Ride Height

Spring preload is a crucial part of setting your motorcycle since it affects the height of the motorcycle and the fork angle.

### **👁 Note!**

Perform the following procedure on a flat surface.

1. Put the motorcycle on a workstand so that both wheels are off the ground and the suspension is unloaded.
2. Mark, e.g. with a piece of tape, a point immediately above the rear wheel axle.
3. Measure the distance from the marked point to a fixed point, e.g. the wheel axle (R1).
4. Measure the distance from the bottom of the upper triple clamp to a fixed point, e.g. the front wheel axle (F1).
5. Put the motorcycle on the ground so that the front and the rear suspensions are slightly compressed. Repeat the measuring procedures (R2 and F2).
6. Sit on the motorcycle in normal riding position, properly outfitted in your riding gear. Repeat the measuring procedure (R3 and F3).

### Recommended Measures

If no other recommendations are given in the Mounting Instructions follow the recommended measures below:

#### Free sag (R1-R2), (F1-F2)

Rear	5-15 mm
Front	20-30 mm

#### Ride height (R1-R3), (F1-F3)

Rear	25-35 mm
Front	30-40 mm

### **👁 Note!**

Always check on the Öhlins web site

[www.ohlins.com](http://www.ohlins.com) or with your Öhlins

dealer/ distributor for the latest information.

## Step 2

### Adjust spring preload

1. If your measures differ significantly from the recommendations in the Mounting Instructions or the table above, adjust the spring preload. (See chapter Spring Preload in this manual).
2. If the ride height still differs from the recommendations, you may need to change to softer/harder spring. Contact an Öhlins dealer for advise.

### **⚠ Warning!**

Incorrect spring rate may result in a front geometry that is either too steep or too flat. This can result in a tendency of under or over steering, that could seriously affect the handling characteristics of the motorcycle.

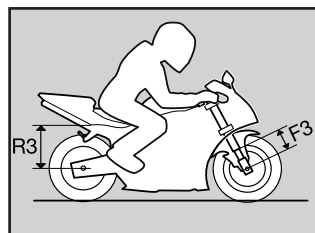
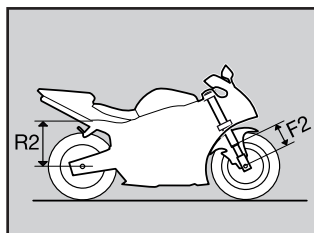
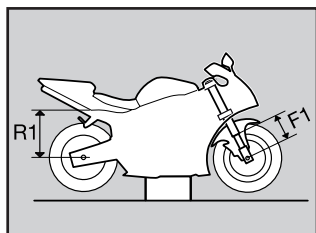

# ADJUSTMENTS

## Stability and Traction

All motorcycles are designed with a suspension geometry that includes height and fork angle. Changing components can affect this and it is therefore essential that both the front and the rear ends match each other.

Changing to Öhlins suspension gives optimum performance only when both the front fork and the rear suspension interact properly. It is very important that the front and the rear loaded heights are within the specified values.

## Front Fork Springs

To optimize the stability and traction of your motorcycle the front fork must match the rear suspension. Öhlins Racing has a variety of front fork springs available for a large number of motorcycle models.

The springs in combination with the Öhlins shock absorbers contribute to superior stability and traction. See the Öhlins Recommendation List, contact an Öhlins dealer.

### **Warning!**

*If there are no matching springs for your motorcycle model, use the original springs, however, they must be in good condition and not fatigued.*

## FGK kits and Piston kits

Öhlins Racing also produces complete Racing Cartridge Systems, for front forks, as well as piston kits to upgrade your front fork to a higher performance level.

## Prepare the Settings

By adjusting the shock absorber and testing by trial and error you can learn how the different settings affect your motorcycle.

Always begin your setting by taking a test ride with all adjustments at their recommended basic setting. Choose a short run of varying character, for example with long as well as sharp bends, hard as well as soft bumps. Stay on the same run and adjust only one setting at a time.

## Adjustments

Most Öhlins shock absorbers for motorcycle are equipped with spring preload, compression and rebound adjusters. Due to limited space in some vehicles it is not possible to have all adjusters in certain models. The three adjusters mentioned above will be discussed in the following chapters.

A deeper understanding for the different types of adjustments will give you a good knowledge of how you can get better performance from your Öhlins shock absorber.

When you adjust the **spring preload**, you move the spring seat. This will lower or raise the ride height.

**Compression** damping controls the energy absorption when the shock absorber is being compressed, thus controls how easy the shock absorber compresses when you hit a bump.

**Rebound** damping controls the energy absorption when the shock absorber is being extended and, thus controls how fast the shock absorber returns to its normal position after being compressed.

### **Note!**

*When riding with a passenger or changing the load, the spring preload must be adjusted for proper function and vehicle balance.*

1. First, check the headlight angle by placing the vehicle about 5m from a wall, with the rider in normal riding position.
2. Turn on the headlight.
3. Mark the centre of the light on the wall with a piece of tape. When you have a passenger or when you put packing on the vehicle, the headlight angle will be too high.
4. Adjust the spring preload until the headlight angle is the same as before but with the passenger or extra load on the bike.



# SPRING PRELOAD

When adjusting the spring preload you move the spring seat. This will decrease or increase the initial spring force, which will lower or raise the motorcycle rear ride height.

The spring preload is fundamental for the suspension function. If the preload is incorrectly set, any other adjustments will not help to get the intended performance from the suspension.

## How to Set the Spring Preload

### 1 Mechanical Adjuster

Use a C-spanner. Loosen the lock nut (1A). Move the lower spring platform (1B) to the desired position. Turn clockwise to increase the preload, turn counter clockwise to decrease it.

### 2 Hydraulic Adjuster

Turn the Hydraulic Adjuster knob to set the spring preload. Turn clockwise to increase the preload and turn counter clockwise to decrease.

### 3 Integrated Hydraulic Adjuster

Turn the hexagon screw on the hydraulic adjuster to set the spring preload. Turn clockwise to increase, turn counter clockwise to decrease.

### 4 Mechanical 3-Step Adjuster

Use two C-spanners. Turn the adjustment rings. There are three [3] adjustment positions (A, B and C).

### 5 Mechanical Adjuster

Unlock the nylon screw on the spring adjuster with a screwdriver (5A). Use tool 03199-01 and turn the spring adjuster clockwise to increase the preload (5B), turn counter clockwise to decrease it.

## Spring Preload

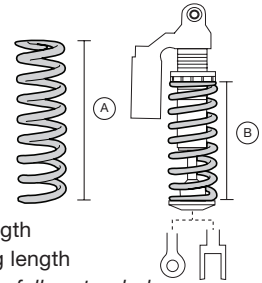

A Free spring length

B Installed spring length

Shock absorber fully extended

$A - B = \text{Spring Preload}$

Spring Preload is the difference between the measures A and B.

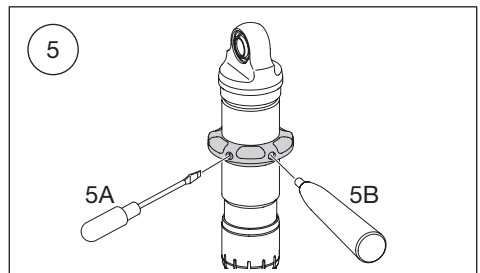
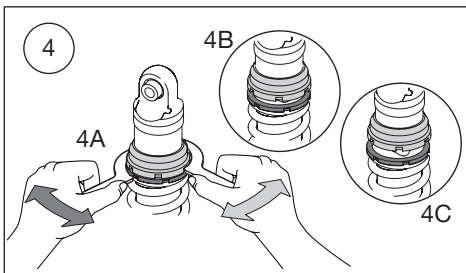
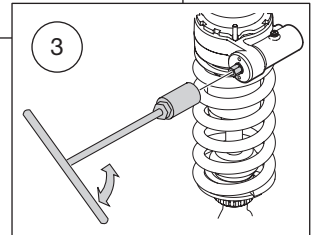
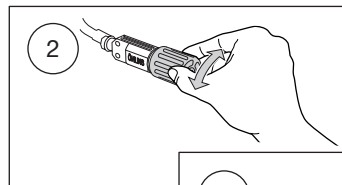
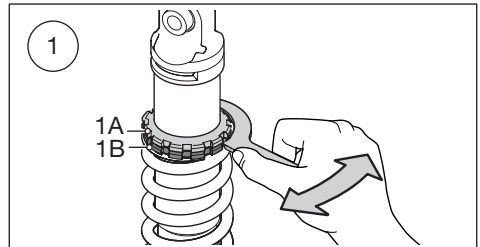

# COMPRESSION DAMPING

Compression damping controls the energy absorption when the shock absorber is being compressed, thus controls how easy the shock absorber compresses when the rear wheel is being loaded or hits a bump.

## Compression Damping Adjuster

### Adjuster Type 1

Adjust by turning the knob on top of the reservoir. Turn clockwise to increase damping, turn counter clockwise to decrease.

### Adjuster Type 2

Adjust by turning the knob on top of the reservoir. Turn clockwise to increase damping, turn counter clockwise to decrease.

### Adjuster Type 3

Adjust on top of the reservoir. Turn the slotted screw clockwise to increase damping, turn counter clockwise to decrease.

### Adjuster Type 4

Adjust on top of the reservoir.  
High speed: Turn the hexagon screw.  
Low speed: Turn the slotted centre screw.

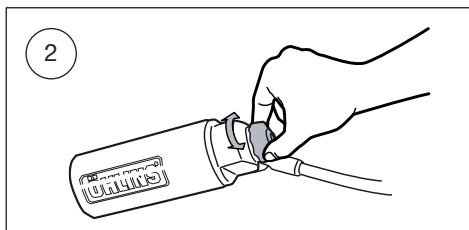
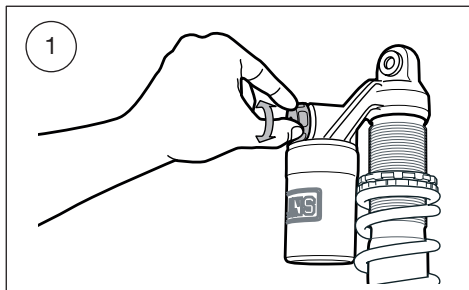

## Reset the adjuster

1. Turn the adjuster clockwise to fully closed position (position zero [0]).
2. Turn counter clockwise to open, and count the clicks until you reach the recommended number of clicks.

See recommended Set-up data in the Mounting Instructions for the shock absorber.

## Caution!

*Do not use force, delicate sealing surfaces can be damaged.*

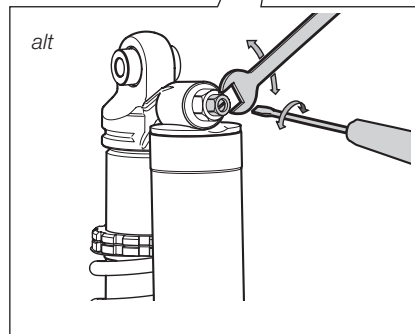
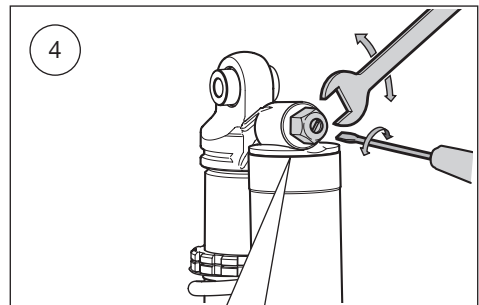
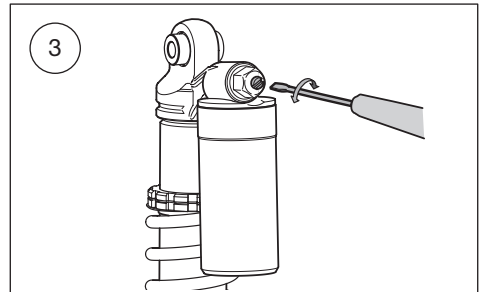

# REBOUND DAMPING

*Rebound damping controls the energy absorption when the shock absorber is being extended and controls how fast the shock absorber returns to its normal position after being compressed.*

## **Rebound Damping Adjuster**

Turn the wheel on the piston shaft above the end eye/bracket. Turn clockwise to increase damping, turn counter clockwise to decrease it.

## **Reset the adjuster**

Turn the adjuster clockwise to fully closed position (position zero [0]). Then, turn counter clockwise to open, and count the clicks until you reach the recommended number of clicks. See recommended Set-up data in the Mounting Instructions for the shock absorber.

### **Caution!**

*Do not use force, delicate sealing surfaces can be damaged.*

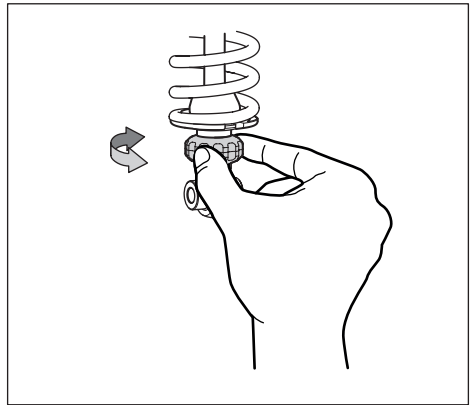
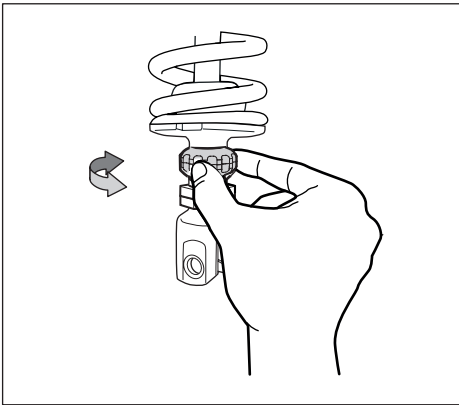

# ADJUST LENGTH

By adjusting the length of the shock absorber the steering geometry as well as the chain force can be changed.

A shorter shock absorber will result in a lower motorcycle. The fork angle as well as the trail will increase, and normally the chain force will be reduced with less anti-squat as a result. A slight change of centre of gravity is another result of changing the length of the shock absorber.

A longer shock absorber will result in a higher motorcycle. The fork angle and trail will decrease and normally the chain force will increase with more anti-squat as a result. A slight change of centre of gravity is another result of changing the length of the shock absorber.

## 👁️ **Note!**

On modern Hypersport and race bikes all length adjustment should be moderate. Also very small adjustments can make a big difference.

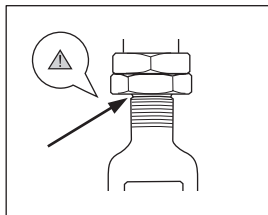
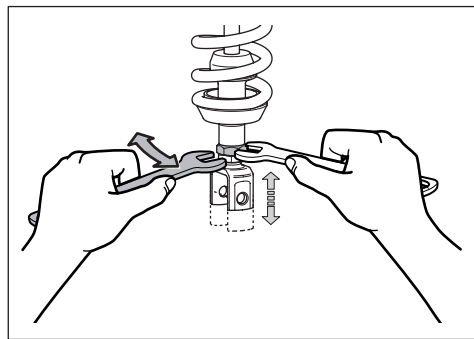

## **Adjust Length**

We advise to remove the shock absorber from the vehicle before adjusting the length. Use two 24 mm wrenches. Hold the upper nut with one hand and at the same time loosen the lock nut (lower nut). Turn the end eye/bracket to the desired length. One [1] turn is 1 mm of shock absorber length. Please make sure to measure the ride height before and after adjusting the length (see chapter Setting Up your Vehicle). Tightening torque: 40 Nm

## ⚠️ **Warning!**

Remember to lock the lock nut after adjusting the length.

## ⚠️ **Warning!**

The adjustable end eye/bracket must not be threaded out more than that the groove is fully visible beneath the lock nut. This is maximum length. After adjusting, make sure that the lock nut is tightened.

## 👁️ **Note!**

After adjusting the length, check the headlight angle of your vehicle.

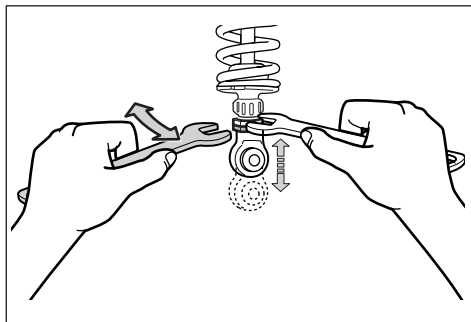

# ADJUSTMENT AND SET-UP

## Recommended Adjustment Range

Rebound and compression damping:  
±5 clicks from original (basic) setting.

When you setup your bike you need to do it together with the front fork and on all types of tracks that you want to optimize, there are no setups that will be 100% perfect on all tracks, you will need to compromise.

Keep priority at:

- safe feeling
- stability
- comfort

This will allow you to ride safer and use less energy.

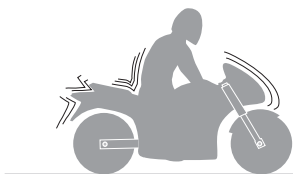

If the vehicle feels

- unstable
- loose
- bouncy

...increase rebound damping

## Rebound Damping

If you have got a good feeling for the bike with spring, preload and the ride height feels ok but the bike runs low and packs down under acceleration bumps, with lost line and/or lost comfort and traction, open the rebound adjuster two [2] clicks.

If the bike is nervous and moving a lot or has a high feeling entering corners, close the rebound adjuster two [2] clicks. Fine tune one [1] click at the time.

Test run and make the necessary adjustments. For original rebound setting see the Mounting Instructions for your shock absorber.

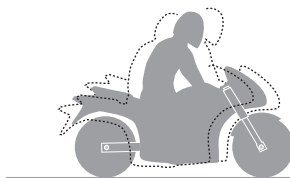

If the vehicle feels

- hard
- bumpy

...decrease rebound damping

# ADJUSTMENT AND SET-UP

## Compression Damping

If the bike feels soft, unstable, is using too much wheel travel and you have the perfect spring for you; close the compression adjuster two [2] clicks. This will control the wheel during acceleration more, plus, it will help ride height and falling through the stroke too quickly.

If the bike feels high, has bad grip at throttle opening and feels unsmooth over small or medium bumps during acceleration; open the compression adjuster two [2] clicks. Test run and make necessary corrections.

When you have sufficient feel of the motorcycle you can make further fine adjustments. It is feeling and experience that counts.

When you feel that you have achieved an improvement, go back to where you started and check once more. Note other relevant factors such as tires, temperature etc. Test run to make sure whether further fine adjustments should be made.

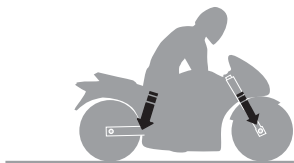

If the vehicle

- feels unstable
- *feels soft*
- feels low
- is bottoming

...increase compression damping

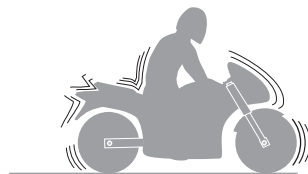

If the vehicle feels

- harsh
- hard
- has bad grip

...decrease compression damping

# INSPECTION AND MAINTENANCE

*Preventive maintenance and regular inspection reduces the risk of functional disturbance. If there is any need for additional service, please contact an authorized Öhlins Service Centre.*

## Cleaning

Clean the shock absorber externally with a soft detergent. Use compressed air. Be careful that all dirt is removed. Lift the bump rubber and clean the area below. Keep the shock absorber clean and spray it with oil (WD40, CRC 5-56 or equivalent) after washing. Wipe off excessive oil with a cloth.

## Caution!

*Never spray water directly into the adjuster knobs and/or the ball joints.*

## Inspection

1. Check ball joints for possible excessive play or stiction.
2. Check the piston shaft for leakage and damage.
3. Check the shock absorber body for external damage.
4. Check the reservoir for external damage that can restrict the floating piston from moving freely.
5. Check for excessive wear of rubber components.
6. Check the attachment points of the shock absorber to the vehicle.

### Recommended Service Intervals

Racing: Every 20 hours of operation.

Regular street use: Every 30 000 km or  
Every 3 years

## Disposal

Discarded Öhlins products should be handed over to an authorized Öhlins workshop or distributor for proper disposal.

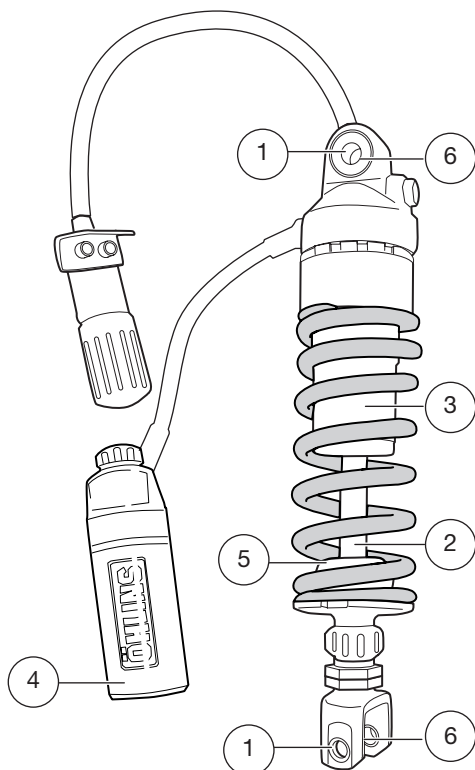

## Note!

*Use only Öhlins Shock Absorber Fluid. Contact an Öhlins dealer for advice.*

## Warning!

*Do not change the gas pressure. Special purpose charging equipment and access to nitrogen is required.*



Your Öhlins retailer:

Öhlins Racing AB  
Box 722  
SE-194 27, Upplands Väsby  
Sweden

Phone: +46 (0)8 590 025 00  
Fax: +46 (0)8 590 025 80  
[www.ohlins.com](http://www.ohlins.com)

